



**5 3 4 3**

**2-Wire  
Level Transmitter**

No. 5343V105-UK  
From ser. no. 141298001



**ATEX**



## Revision Notes

The following list provides notes concerning revisions of this document.

<b>Rev. ID</b>	<b>Date</b>	<b>Notes</b>
104	14/14	IECEX, FM and INMETRO approvals added
105	15/03	GL marine approval added

# 2-WIRE LEVEL TRANSMITTER

## PRELEVEL 5343

### CONTENTS

Application.....	2
Technical characteristics.....	2
Mounting / installation.....	2
Applications.....	3
Order: 5343.....	4
Electrical specifications.....	4
Connections .....	7
Block diagram.....	8
Programming .....	9
Mechanical specifications .....	9
Mounting of sensor wires .....	9
Configuration of potentiometer input.....	10
Activation of embedded linearisations.....	12
Appendix.....	13
ATEX Installation Drawing - 5343A .....	14
ATEX Installation Drawing - 5343B .....	15
IECEX Installation Drawing - 5343A.....	17
IECEX Installation Drawing - 5343B.....	18
FM Installation Drawing - 5343B.....	20
INMETRO Instruções de Segurança - 5343A.....	22
INMETRO Instruções de Segurança - 5343B.....	23

## 2-WIRE LEVEL TRANSMITTER PRELEVEL 5343

- *Potentiometer or Ohmic input*
- *Programmable sensor error value*
- *High measurement accuracy*
- *Unique process calibration function*
- *Programmable via standard PC*

### **Application**

- Conversion of resistance variation to standard analogue current signals, e.g. from Ohmic level sensors or valve positions.
- User-defined linearisation function can be activated.

### **Technical characteristics**

- Within a few seconds the user can program PR5343 to measure within the defined Ohmic values.
- Continuous check of vital stored data for safety reasons.
- The transmitter is protected against polarity reversal.
- PR5343 is configured to the current task by way of a PC, the PRElevel software and the communications interface Loop Link.
- The PRElevel configuration tool included in the PRreset software has been developed specifically for the configuration of level applications. Among other things, it contains a function for "on line" measurement of input span as well as a linearisation function for volume linear output from horizontal cylindrical tanks.

### **Mounting / installation**

- For DIN form B sensor head mounting. In non-hazardous areas the 5343 can be mounted on a DIN rail with a special fitting.

# APPLICATIONS

Ohmsk niveaustav  
til 4...20 mA

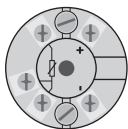

2-Trådsinstallation  
i kontrolrum

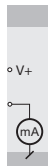

Potentiometer  
til 4...20 mA

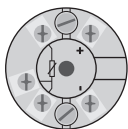
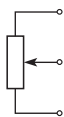

2-Trådsinstallation  
i kontrolrum

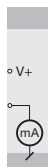

Modstand til 4...20 mA

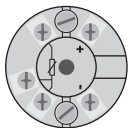
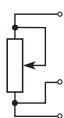

2-Trådsinstallation  
i kontrolrum

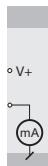

Order: 5343

Type	Version
5343	Standard : A ATEX, FM, IECEx & INMETRO : B

## Electrical specifications

### Specifications range:

-40°C to +85°C

### Common specifications:

Supply voltage, DC

Standard..... 8.0...35 V

ATEX, FM, IECEx & INMETRO..... 8.0...30 V

Internal consumption..... 25 mW...0.8 W

Voltage drop..... 8 VDC

Warm-up time..... 5 min.

Communications interface..... Loop Link

Signal / noise ratio..... Min. 60 dB

Response time (programmable)..... 0.33...60 s

Signal dynamics, input..... 19 bit

Signal dynamics, output..... 16 bit

Calibration temperature..... 20...28°C

Accuracy, the greater of the general and basic values:

General values		
Input type	Absolute accuracy	Temperature coefficient
Lin. R	$\leq \pm 0.1\%$ of span	$\leq \pm 0.01\%$ of span / °C

Basic values		
Input type	Basic accuracy	Temperature coefficient
Lin. R	$\leq \pm 0.05 \Omega$	$\leq \pm 0.002 \Omega / ^\circ\text{C}$

EMC immunity influence.....	$< \pm 0.5\%$ of span
-----------------------------	-----------------------

Effect of supply voltage change.....	< 0.005% of span / VDC
Vibration.....	IEC 60068-2-6 : 2007
2...25 Hz.....	±1.6 mm
25...100 Hz.....	±4 g
Max. wire size.....	1 x 1.5 mm <sup>2</sup> stranded wire
Humidity.....	< 95% RH (non cond.)
Dimensions.....	Ø 44 x 20.2 mm
Protection degree (enclosure / terminal).....	IP68 / IP00
Weight.....	50 g

### Electrical specifications, input:

#### Linear resistance input:

Measurement range.....	0...100 kΩ
Min. measurement range (span).....	1 kΩ
Max. offset.....	50% of selected max. value
Cable resistance per wire (max.).....	100 Ω
Sensor current.....	> 25 μA, < 120 μA
Effect of sensor cable resistance (3-wire).....	< 0.002 Ω / Ω
Sensor error detection.....	Yes

### Output:

#### Current output:

Signal range.....	4...20 mA
Min. signal range.....	16 mA
Updating time.....	135 ms
Load resistance.....	< $(V_{\text{supply}} - 8) / 0.023$ [Ω]
Load stability.....	< ±0.01% of span/100 Ω

#### Sensor error detection:

Programmable.....	3.5...23 mA
NAMUR NE43 Upscale.....	23 mA
NAMUR NE43 Downscale.....	3.5 mA

**Of span** = Of the presently selected range

**Approvals:**

EMC 2004/108/EC .....	EN 61326-1
EAC TR-CU 020/2011 .....	EN 61326-1

**Marine approval:**

Det Norske Veritas, Ships & Offshore .....	Standard for Certification No. 2.4
Germanischer Lloyd .....	VI-7-2

**Ex:**

ATEX 94/9/EC	
5343A .....	KEMA 10ATEX0004 X
5343B .....	KEMA 03ATEX1538 X
FM .....	2D5A7
IECEX .....	DEK 13.0036X
INMETRO .....	DEKRA 13.0002 X
EAC Ex TR-CU 012/2011 .....	RU C-DK.GB08.V.00410



# CONNECTIONS

Input:

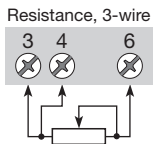
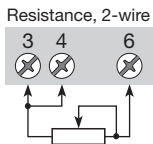
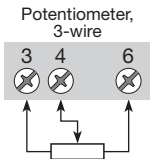

Output:

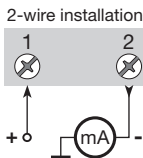

# BLOCK DIAGRAM

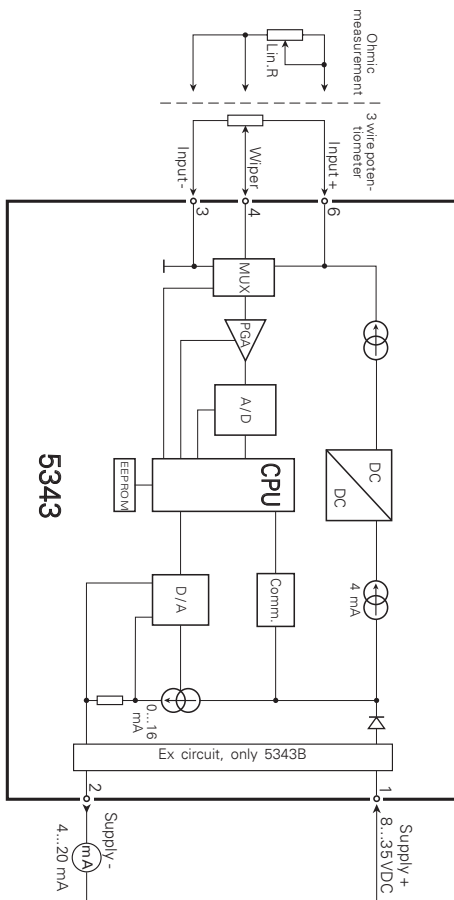

# PROGRAMMING

- Loop Link is a communications interface that is needed for programming PRelevel 5343.
- For programming please refer to the drawing below and the help function in the PRelevel software.
- Loop Link is not approved for communication with modules installed in hazardous (Ex) areas.

## Order: Loop Link

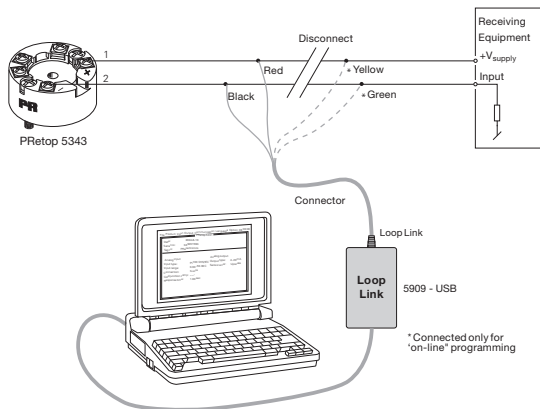

## Mechanical specifications

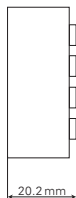
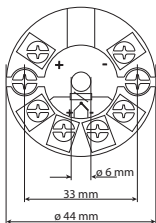

## Mounting of sensor wires

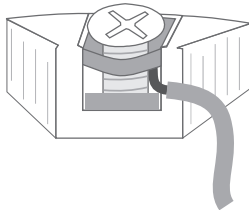

Wires must be mounted between the metal plates.

## CONFIGURATION OF POTENTIOMETER INPUT

In an Ohmic level sensor the resistance value changes when a magnetic floater activates the reed contacts in the sensor. This means that it is usually not possible to make use of the entire level sensor as input span. When PR5343 is used with a potentiometer input, the PRelevel software contains the following special functions for configuration:

**[Calibration Password]** is 4711. This password should be entered at program start. The only parameters which can be changed without entering this password are Input Low and High for the potentiometer input. The menu item is located under **Tools > Options**. Please pay special attention to the text in the **'Information'** window during transmission. When the configuration cannot be sent to the transmitter due to lack of password, the following text will appear: 'Operation aborted.' 'Configuration NOT transmitted to the device.'

**Figure 1**, cross section of horizontal cylindrical tank

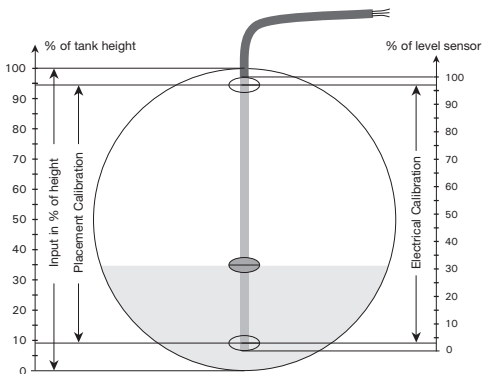

The following description of configuration with potentiometer input is based on figure 1. Please note that the PRelevel software only comes in an English-language version. Therefore the menu texts are represented here as they are seen on the screen. First choose the **[Input]** tab:

**[Electrical Calibration]** Enter the range to be detected by the connected potentiometer or let PRelevel measure the available range. The transmitter must be connected to the communications interface before the values can be measured. The values in figure 1 are Low = 3% og High = 97%.

**[Placement Calibration]** Enter the placement of the 'Electrical Calibration' Low and High points of the level sensor in relation to the height of the tank. These values are used for calculation of linearisation values and for calculation of 0 and 100% height.

The values in figure 1 are Low = 9% and High = 94%.

**[Input]** Enter the desired input span in relation to the height. When input Low and High are selected as 0 and 100%, the input can never go below 9% and above 94% due to the design and mounting of the level sensor. If the output span is 4...20 mA, the output will only vary between 5.44...19.04 mA.

The values in figure 1 are Low = 0% and High = 100%.

## ACTIVATION OF EMBEDDED LINEARISATIONS

The PRelevel software contains embedded linearisation functions for horizontal cylindrical tanks and spherical tanks. The linearisation functions can be activated as follows:

**Custom input type:** In order to gain access to a customer-defined linearisation, the selection in the **[General Type]** input box must end with the text 'Custom' and the **[Calibration Password]** 4711 must be entered.

**Activation of linearisation:** Choose the **[Options]** tab in the PRelevel 5343 window. If one of the embedded linearisations is to be used, the selection in the 'Linearisation' window must be 'Polynomial.....(Relative)' in order to retrieve the most accurate linearisation files. The files are retrieved by way of the following menus: >**Specify** + select >**File** > **Open** in the main menu + select >**File name** >**Open** in the file dialogue box.

**User-defined linearisation:** It is possible to enter specific linearisation tables in the >**Specify** menu.

# APPENDIX

**ATEX INSTALLATION DRAWING - 5343A**

**ATEX INSTALLATION DRAWING - 5343B**

**IECEX INSTALLATION DRAWING - 5343A**

**IECEX INSTALLATION DRAWING - 5343B**

**FM INSTALLATION DRAWING - 5343B**

**INMETRO INSTRUÇÕES DE SEGURANÇA - 5343A**

**INMETRO INSTRUÇÕES DE SEGURANÇA - 5343B**

## ATEX Installation drawing

For safe installation of 5343A the following must be observed. The module shall only be installed by qualified personnel who are familiar with the national and international laws, directives and standards that apply to this area.

Year of manufacture can be taken from the first two digits in the serial number.

ATEX Certificate      KEMA 10ATEX 0004X

Marking



II 3 G Ex nA [ic] IIC T4 ... T6 Gc  
II 3 G Ex ic IIC T4...T6 Gc  
II 3 D Ex ic IIIC Dc

Standards              EN 60079-0 : 2012, EN 60079-11 : 2012, EN 60079-15 : 2010

T4: $-40 \leq T_a \leq 85^\circ\text{C}$	<b>Terminal: 3,4,6</b>	<b>Terminal: 1,2</b>	<b>Terminal: 1,2</b>
T6: $-40 \leq T_a \leq 60^\circ\text{C}$	Ex nA [ic]	Ex nA	Ex ic
	Uo: 5V	Umax $\leq 35$ VDC	Ui = 35 VDC
	Io: 4 mA		Ii = 110 mA
	Po: 20 mW		Li = 10 $\mu\text{H}$
	Lo: 900 mH		Ci = 1.0 nF
	Co: 1000 $\mu\text{F}$		

### Special conditions for safe use.

For type of protection Ex nA, the transmitter shall be mounted in a metal enclosure providing a degree of protection of at least IP54 according to EN60529.

For use in the presence of combustible dusts the transmitter shall be mounted in an enclosure providing a degree of protection of at least IP6X in accordance with EN60529, the surface temperature of the outer enclosure is 20 K above the ambient temperature

For an ambient temperature  $\geq 60^\circ\text{C}$ , heat resistant cables shall be used with a rating of at least 20 K above the ambient temperature.



## ATEX Installation drawing



For safe installation of 5343B the following must be observed. The module shall only be installed by qualified personnel who are familiar with the national and international laws, directives and standards that apply to this area.

Year of manufacture can be taken from the first two digits in the serial number.

ATEX Certificate      KEMA 03ATEX 1538 X

Marking



II 1 G Ex ia IIC T4...T6 Ga  
II 1 D Ex ia IIIC Da  
II 1 M Ex ia I Ma

Standards              EN 60079-0 : 2012, EN 60079-11 : 2012, EN 60079-26 : 2007,

Hazardous area

Zone 0, 1, 2, 20, 21, 22

T4:  $-40 \leq T_a \leq 85^\circ\text{C}$

T6:  $-40 \leq T_a \leq 60^\circ\text{C}$

**Terminal: 3,4,6**

U<sub>o</sub>: 30 VDC

I<sub>o</sub>: 8 mA

P<sub>o</sub>: 60 mW

L<sub>o</sub>: 35 mH

Co: 66 nF

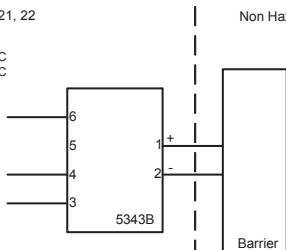

**Terminal: 1,2**

U<sub>i</sub>: 30 VDC

I<sub>i</sub>: 120 mA

P<sub>i</sub>: 0.84 W

L<sub>i</sub>: 10  $\mu\text{H}$

C<sub>i</sub>: 1.0 nF

**Installation notes.**

In a potentially explosive gas atmosphere, the transmitter shall be mounted in an enclosure in order to provide a degree of protection of at least IP20 according to EN60529.

If the transmitter is installed in an explosive atmosphere requiring the use of equipment of category 1 G, 1 M or 2 M, and if the enclosure is made of aluminum, it must be installed such that ignition sources due to impact and friction sparks are excluded.

If the enclosure is made of non-metallic materials, electrostatic charging shall be avoided.

For installation in a potentially explosive dust atmosphere, the following instructions apply:

The transmitter shall be mounted in a metal enclosure form B according to DIN43729 that is providing a degree of protection of at least IP6X according to EN60529, that is suitable for the application and correctly installed.

Cable entries and blanking elements shall be used that are suitable for the application and correctly installed.

For an ambient temperature  $\geq 60^{\circ}\text{C}$ , heat resistant cables shall be used with a rating of at least 20 K above the ambient temperature.

The surface temperature of the enclosure is equal to the ambient temperature plus 20 K, for a dust layer with a thickness up to 5 mm.

## IECEx Installation drawing



For safe installation of 5333A or 5343A the following must be observed. The module shall only be installed by qualified personnel who are familiar with the national and international laws, directives and standards that apply to this area.  
Year of manufacture can be taken from the first two digits in the serial number.

Certificate	IECEx DEK 13.0036X		
Marking	Ex nA [ic] IIC T6..T4 Gc	T4: $-40 \leq T_a \leq 85^\circ\text{C}$	
	Ex ic IIC T6..T4 Gc	T6: $-40 \leq T_a \leq 60^\circ\text{C}$	
	Ex ic IIIC Dc		
Standards	IEC 60079-0 : 2011, IEC 60079-11 : 2011, IEC 60079-15 : 2010		

Terminal	Ex nA [ic]	Ex ic
1,2	$U_{\max} = 35\text{V}$	$U_i : 35\text{V}, I_i : 110\text{mA}, I_i : 10\mu\text{H}, C_i : 1,0\text{nF}$
3,4,6	$U_o : 5\text{V}, I_o : 4\text{mA}, P_o : 20\text{mW}, L_o : 900\text{mH}, C_o : 1000\mu\text{F}$	

### Installation note:

For installation in a potentially explosive gas atmosphere, the following instructions apply:

For nA installation the transmitter must be installed in an metal enclosure e.g. a form B enclosure, providing a degree of protection of at least IP54 according to IEC60529 or in an enclosure with type of protection Ex n or Ex e.

For ic installation the transmitter must be installed in enclosure providing a degree of protection of at least IP20 according to IEC60529 and that is suitable for the application.

Cable entry devices and blanking elements shall fulfill the same requirements

For an ambient temperature  $\geq 60^\circ\text{C}$ , heat resistant cables shall be used with a rating of at least 20 K above the ambient temperature.

For installation in a potentially explosive dust atmosphere, the following instructions apply:

The surface temperature of the enclosure is equal to the ambient temperature plus 20 K, for a dust layer with a thickness up to 5 mm.

The transmitter must be mounted in a enclosure according to DIN 43729 that provides a degree of protection of at least IP6X according to IEC60529, and that is suitable for the application. Cable entry devices and blanking elements shall fulfill the same requirements.

## IECEX Installation drawing



For safe installation of 5333D or 5343B the following must be observed. The module shall only be installed by qualified personnel who are familiar with the national and international laws, directives and standards that apply to this area.

Year of manufacture can be taken from the first two digits in the serial number.

Certificate	IECEX DEK 13.0036X
Marking	Ex ia IIC T4...T6 Ga Ex ia IIC Da Ex ia I Ma
Standards	IEC 60079-0 : 2011, IEC 60079-11 : 2011, IEC 60079-26:2006

Hazardous area  
Zone 0, 1, 2, 20, 21, 22, M1

T4:  $-40 \leq T_a \leq 85^\circ\text{C}$

T5:  $-40 \leq T_a \leq 60^\circ\text{C}$

T6:  $-40 \leq T_a \leq 45^\circ\text{C}$

Non Hazardous Area

**Terminal: 3, 4, 6**

U<sub>o</sub>: 30 VDC

I<sub>o</sub>: 8 mA

P<sub>o</sub>: 60 mW

L<sub>o</sub>: 35 mH

C<sub>o</sub>: 66 nF

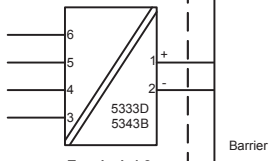

**Terminal: 1, 2**

U<sub>i</sub>: 30 VDC

I<sub>i</sub>: 120 mA

P<sub>i</sub>: 0.84 W

L<sub>i</sub>: 10 $\mu$ H

C<sub>i</sub>: 1.0nF

**Installation notes.**

In a potentially explosive gas atmosphere, the transmitter shall be mounted in a metal form B enclosure in order to provide a degree of protection of at least IP20 according to IEC60529. If however the environment requires a higher degree of protection, this shall be taken into account.

If the transmitter is installed in an explosive atmosphere requiring the use of equipment protection level Ga, Ma and Mb, and if the enclosure is made of aluminum, it must be installed such, that ignition sources due to impact and friction sparks are excluded.

For installation in a potentially explosive dust atmosphere, the following instructions apply:

For explosive dust atmospheres, the surface temperature of the outer enclosure is 20 K above the ambient temperature.

The transmitter shall be mounted in a metal enclosure form B according to DIN43729 that is providing a degree of protection of at least IP6X according to IEC60529, that is suitable for the application and correctly installed.

Cable entries and blanking elements shall be used that are suitable for the application and correctly installed.

For an ambient temperature  $\geq 60^{\circ}\text{C}$ , heat resistant cables shall be used with a rating of at least 20 K above the ambient temperature.

## FM Installation Drawing 5300Q502

### Model 5331C, 5331D, 5333C, 5333D and 5343B

#### Hazardous (Classified) Location

Class I, Division 1, Groups, A, B, C, D  
Class I, Zone 0, IIC

Ambient temperature limits  
T4: -40 to +85 deg. Celsius  
T6: -40 to +60 deg. Celsius

Terminal 1, 2  
Vmax or Ui: 30 V  
Imax or Ii: 120 mA  
Pmax or Pi: 0.84 W  
Ci: 1 nF  
Li: 10 uH

Terminal 3, 4, 5, 6  
Only passive, or non-energy storing devices such as RTD's and Thermocouples may be connected.

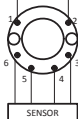

#### Non Hazardous Location

Associated Apparatus or Barrier with entity Parameters:

$UM \leq 250V$   
 $V_{oc} \text{ or } U_o \leq V_{max} \text{ or } U_i$   
 $I_{sc} \text{ or } I_o \leq I_{max} \text{ or } I_i$   
 $P_o \leq P_i$   
 $C_a \text{ or } C_o \geq C_i + C_{cable}$   
 $L_a \text{ or } L_o \geq L_i + L_{cable}$

This device must not be connected to any associated apparatus which uses or generates more than 250 VRMS

### Model 5335C, 5335D, 5336D, 5337D

#### Hazardous (Classified) Location

Class I, Division 1, Groups, A, B, C, D  
Class I, Zone 0, IIC

Ambient temperature limits  
T4: -40 to +85 deg. Celsius  
T6: -40 to +60 deg. Celsius

Terminal 1, 2  
Vmax or Ui: 30 V  
Imax or Ii: 120 mA  
Pmax or Pi: 0.84 W  
Ci: 1 nF  
Li: 10 uH

Terminal 3, 4, 5, 6  
Vi or Uo: 9.6 V  
Ii or Io: 28 mA  
Pi or Po: 67.2 mW  
Ca or Co: 3.5 uF  
La or Lo: 35 mH

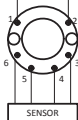

#### Non Hazardous Location

Associated Apparatus or Barrier with entity Parameters:

$UM \leq 250V$   
 $V_{oc} \text{ or } U_o \leq V_{max} \text{ or } U_i$   
 $I_{sc} \text{ or } I_o \leq I_{max} \text{ or } I_i$   
 $P_o \leq P_i$   
 $C_a \text{ or } C_o \geq C_i + C_{cable}$   
 $L_a \text{ or } L_o \geq L_i + L_{cable}$

This device must not be connected to any associated apparatus which uses or generates more than 250 VRMS

### The entity concept

The Transmitter must be installed according to National Electrical Code (ANSI-NFPA 70) and shall be installed with the enclosure, mounting, and spacing segregation requirement of the ultimate application.

Equipment that is FM-approved for intrinsic safety may be connected to barriers based on the ENTITY CONCEPT. This concept permits interconnection of approved transmitters, meters and other devices in combinations which have not been specifically examined by FM, provided that the agency's criteria are met. The combination is then intrinsically safe, if the entity concept is acceptable to the authority having jurisdiction over the installation.

The entity concept criteria are as follows:

The intrinsically safe devices, other than barriers, must not be a source of power.

The maximum voltage  $U_i(V_{MAX})$  and current  $I_i(I_{MAX})$ , and maximum power  $P_i(P_{MAX})$ , which the device can receive and remain intrinsically safe, must be equal to or greater than the voltage ( $U_o$  or  $V_{OC}$  or  $V_i$ ) and current ( $I_o$  or  $I_{SC}$  or  $I_i$ ) and the power  $P_o$  which can be delivered by the barrier.

The sum of the maximum unprotected capacitance ( $C_i$ ) for each intrinsically device and the interconnecting wiring must be less than the capacitance ( $C_a$ ) which can be safely connected to the barrier.

The sum of the maximum unprotected inductance ( $L_i$ ) for each intrinsically device and the interconnecting wiring must be less than the inductance ( $L_a$ ) which can be safely connected to the barrier.

The entity parameters  $U_o, V_{OC}$  or  $V_i$  and  $I_o, I_{SC}$  or  $I_i$ , and  $C_a$  and  $L_a$  for barriers are provided by the barrier manufacturer.

### NI Field Circuit Parameters

## Model 5331C, 5331D, 5333C, 5333D, 5335C, 5335D, 5336D, 5337D and 5343B

#### Hazardous (Classified) Location

Class I, Division 2, Groups, A, B, C, D  
Class I, Zone 2, IIC

Ambient temperature limits  
T4: -40 to +85 deg. Celsius  
T6: -40 to +60 deg. Celsius

Terminal 1, 2  
 $V_{max}$ : 35 V  
 $C_i$ : 0  $\mu$ F  
 $L_i$ : 10  $\mu$ H

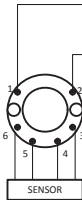

#### Non Hazardous Location

Associated Apparatus  
or Barrier

This device must not be connected to any associated apparatus which uses or generates more than 250 VRMS

## Desenho de Instalação InNMETRO



Para instalação segura do 5333A ou 5343A o seguinte deve ser observado. O modo deve apenas ser instalado por pessoas qualificadas que são familiarizadas com as leis nacionais e internacionais, diretrizes e padrões que se aplicam a esta área.  
Ano de fabricação pode ser pego dos dois primeiros dígitos do número de série.

Certificado	IECEX DEK 13.0002 X	
Indicação	Ex nA [ic] IIC T6..T4 Gc	T4: $-40 \leq T_a \leq 85^{\circ}\text{C}$
	Ex ic IIC T6..T4 Gc	T6: $-40 \leq T_a \leq 60^{\circ}\text{C}$
	Ex ic IIIC Dc	

Padrões ABNT NBR IEC 60079-0 : 2008, ABNT NBR IEC 60079-11 : 2009,  
IEC 60079-15 : 2010, ABNT NBR IEC 60079-26 : 2008

Terminal	Ex nA [ic]	Ex ic
1,2	U <sub>max</sub> = 35V	Ui : 35V, li:110mA, li:10μH, Ci:1,0nF
3,4,6	Uo: 5V, Io: 4mA,	Po: 20mW, Lo: 900mH, Co: 1000μF

### Notas para instalação

Para a instalação em uma atmosfera de gás potencialmente explosivo, se aplicam as instruções a seguir:

Para a instalação nA o transmissor deve ser instalado em um gabinete de metal, por exemplo, gabinete em forma B que forneça um grau de proteção de pelo menos IP54 de acordo com IEC60529 ou em um caixa com tipo de proteção Ex n ou Ex e.

Para a instalação iC o transmissor deve ser instalado em um invólucro proporcionando um grau de proteção de IP20, pelo menos, de acordo com a norma IEC60529 que é adequado para a aplicação.

Dispositivos de entrada de cabos e elementos de supressão devem cumprir os mesmos requisitos.

Para uma temperatura ambiente  $\geq 60^{\circ}\text{C}$ , os cabos resistentes ao calor precisam ser utilizados com uma classificação de pelo menos 20 K acima da temperatura ambiente.

Para a instalação em uma atmosfera de poeira potencialmente explosiva, se aplicam as instruções a seguir:

A temperatura da superfície do invólucro é igual à temperatura ambiente mais 20 K, para uma camada de pó, com uma espessura superior a 5 mm.

O transmissor deve ser montado em um invólucro de acordo com a norma DIN 43729, que proporciona um grau de proteção de, pelo menos, IP6X de acordo com a norma IEC60529, e que seja apropriado para a aplicação.

Dispositivos de entrada de cabos e elementos de supressão devem cumprir as mesmas exigências



## Desenho de Instalação InMETRO



Para instalação segura do 5333D ou 5343B o seguinte deve ser observado. O modo deve apenas ser instalado por pessoas qualificadas que são familiarizadas com as leis nacionais e internacionais, diretrizes e padrões que se aplicam a esta área.  
Ano de fabricação pode ser pegos dos dois primeiros dígitos do número de série.

Certificado DEKRA 13.0002 X

Indicação Ex ia IIC T6...T4 Ga  
Ex ia IIIC Da

Padrões ABNT NBR IEC 60079-0 : 2008, ABNT NBR IEC 60079-11 : 2009,  
IEC 60079-15 : 2010, ABNT NBR IEC 60079-26 : 2008

### Áreas perigosas

Zona 0, 1, 2, 20, 21, 22, M1

T4:  $-40 \leq T_a \leq 85^\circ\text{C}$

T5:  $-40 \leq T_a \leq 60^\circ\text{C}$

T6:  $-40 \leq T_a \leq 45^\circ\text{C}$

Sem áreas perigosas

### Terminal: 3,4,5,6

Uo: 30 VDC

Io: 8 mA

Po: 60 mW

Lo: 35 mH

Co: 66 nF

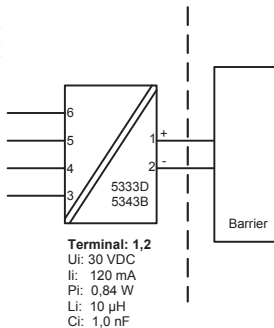

**Notas de Instalação.**

Em uma atmosfera de gás potencialmente explosiva, o transmissor deve ser montado em um enclosure a fim de garantir um grau de proteção de no mínimo IP20 de acordo com EN60529. Se contudo o ambiente requer um nível de proteção maior, isso deve ser levado em conta

Se o transmissor é instalado em uma atmosfera explosiva exigindo o uso de equipamento de categoria Ga e se o enclosure é feito de alumínio, ele deve ser instalado de modo que, mesmo em caso de avaria rara, fontes de ignição devido a impacto e fricção, faíscas são eliminadas; se o enclosure é feito de materiais não metálicos, cargas eletroestáticas devem ser evitadas.

Para instalação em atmosfera de poeira potencialmente explosiva, as instruções a seguir:

O transmissor deve ser montado em enclosure de metal forma B de acordo com DIN43729 que está fornecendo um grau de proteção de pelo menos IP6X de acordo com EN60529. Isso é adequado para aplicação e corretamente instalado.

As entradas dos cabos e os elementos de obturação que podem ser utilizados são adequados para a aplicação e corretamente instalados.

Para temperatura ambiente  $\geq 60^{\circ}\text{C}$ , fios de resistência ao calor devem ser usados com uma faixa de pelo menos 20K acima da temperatura ambiente.

A temperatura da superfície do enclosure é igual à temperatura ambiente mais de 20 K, por uma camada de pó, com uma espessura até 5 mm.



**Displays** Programmable displays with a wide selection of inputs and outputs for display of temperature, volume and weight, etc. Feature linearization, scaling, and difference measurement functions for programming via PReset software.



**Ex interfaces** Interfaces for analog and digital signals as well as HART® signals between sensors / I/P converters / frequency signals and control systems in Ex zone 0, 1 & 2 and for some devices in zone 20, 21 & 22.



**Isolation** Galvanic isolators for analog and digital signals as well as HART® signals. A wide product range with both loop-powered and universal isolators featuring linearization, inversion, and scaling of output signals.





























**Temperature** A wide selection of transmitters for DIN form B mounting and DIN rail devices with analog and digital bus communication ranging from application-specific to universal transmitters.



**Universal** PC or front programmable devices with universal options for input, output and supply. This range offers a number of advanced features such as process calibration, linearization and auto-diagnosis.



- 

[www.preelectronics.fr](http://www.preelectronics.fr)  

[sales-fr@preelectronics.com](mailto:sales-fr@preelectronics.com)
- 

[www.preelectronics.de](http://www.preelectronics.de)  

[sales-de@preelectronics.com](mailto:sales-de@preelectronics.com)
- 

[www.preelectronics.es](http://www.preelectronics.es)  

[sales-es@preelectronics.com](mailto:sales-es@preelectronics.com)
- 

[www.preelectronics.it](http://www.preelectronics.it)  

[sales-it@preelectronics.com](mailto:sales-it@preelectronics.com)
- 

[www.preelectronics.se](http://www.preelectronics.se)  

[sales-se@preelectronics.com](mailto:sales-se@preelectronics.com)
- 

[www.preelectronics.com](http://www.preelectronics.com)  

[sales-uk@preelectronics.com](mailto:sales-uk@preelectronics.com)
- 

[www.preelectronics.com](http://www.preelectronics.com)  

[sales-us@preelectronics.com](mailto:sales-us@preelectronics.com)
- 

[www.preelectronics.cn](http://www.preelectronics.cn)  

[sales-cn@preelectronics.com](mailto:sales-cn@preelectronics.com)
- 

[www.preelectronics.be](http://www.preelectronics.be)  

[sales-be@preelectronics.com](mailto:sales-be@preelectronics.com)

## Head office

Denmark  
 PR electronics A/S  
 Lerbakken 10  
 DK-8410 Rønede

[www.preelectronics.com](http://www.preelectronics.com)  
[sales-dk@preelectronics.com](mailto:sales-dk@preelectronics.com)  
 tel. +45 86 37 26 77  
 fax +45 86 37 30 85



QUALITY SYSTEM AND ENVIRONMENTAL  
 MANAGEMENT SYSTEM  
 DS/EN ISO 9001  
 DS/EN ISO 14001

